

2002-01-01

Performance study of UPQC for load compensation and voltage sag mitigation

Malabika Basu

Technological University Dublin, mbasu@tudublin.ie

S. P. Das

Indian Institute of Technology - Kanpur

Gopal Dubey

Indian Institute of Technology - Kanpur

Follow this and additional works at: <https://arrow.tudublin.ie/engscheleart>



Part of the [Electrical and Computer Engineering Commons](#)

Recommended Citation

Basu, Malabika and Das, S. P. and Dubey, Gopal :Performance study of UPQC for load compensation and voltage sag mitigation. IECON 02: 28th Annual Conference of the Industrial Electronics Society, IEEE, 5-8 Nov., 2002, vol.1, pp.698-703. doi:10.21427/t328-5r12

This Conference Paper is brought to you for free and open access by the School of Electrical and Electronic Engineering at ARROW@TU Dublin. It has been accepted for inclusion in Conference papers by an authorized administrator of ARROW@TU Dublin. For more information, please contact arrow.admin@tudublin.ie, aisling.coyne@tudublin.ie.



This work is licensed under a [Creative Commons Attribution-NonCommercial-Share Alike 4.0 License](#)
Funder: Department of Science and Technology,
Government of India

Performance Study of UPQC-Q for Load Compensation and Voltage Sag Mitigation

Malabika Basu

Department of Electrical
Engineering
Indian Institute of Technology
Kanpur, India
mbasu@iitk.ac.in

S. P. Das

Department of Electrical
Engineering
Indian Institute of Technology
Kanpur, India
spdas@iitk.ac.in

Gopal K. Dubey

Department of Electrical
Engineering
Indian Institute of Technology
Kanpur, India
gdubey@iitk.ac.in

Abstract. Unified Power Quality Conditioner (UPQC) is one of the major custom power solutions that is capable of mitigating the effect of supply voltage sag at the load end or the Point of Common Coupling (PCC). It also prevents load current harmonics from entering the utility and corrects the input power factor of the load. The control of series compensator is such that it injects voltage in quadrature advance to the supply current, so that no active power is consumed by the series compensator at steady state. The UPQC employing this type of quadrature voltage injection in series is termed UPQC-Q. The present paper discusses the VA requirement issues of series and shunt compensators of UPQC-Q and its performance is verified in a laboratory prototype. The phasor diagram, control block diagram and typical experimental results are presented to confirm the validity of the theory.

Index Terms: Harmonic elimination, Power Quality, UPQC-Q, Voltage sag

I. INTRODUCTION

Power Quality (PQ) is expected to be treated as commodity in the open market economy now a days due to deregulation in the power sectors of transmission and distribution. Therefore PQ parameters are required to follow stringent figures-of-merit (some world-wide accepted standards like IEC-1000-2-2, IEEE-519-1992 etc.) that decide the consumer preference and equipment design limits (IEC-1000-3-2, IEC-1000-3-4 etc) [1]. Most of the voltage sensitive critical loads are non-linear in nature, due to application of fast acting semiconductor switches and their specific control strategy. Undoubtedly, they have revolutionized the state of the art technology in almost every field, but their large scale presence in a system pose some major concerns as they affect the distribution utility in some highly undesirable way.

Primarily, these kinds of load currents are rich in harmonics and they may require some reactive VA as well. The harmonic currents flowing through the finite source impedance of the utility supply cause the voltage distortion at the Point of Common Coupling (PCC). It results in malfunction of control equipment, protection and metering of other loads and system metering devices. Harmonic currents can also cause excitation of system resonance, overloading of capacitors, decrease in the efficiency due to increased losses owing to harmonic currents, interference with communication and control signals, saturation and overheating of distribution transformers and distribution lines.

Poor power factor operation of the loads implies ineffective use of the volt-ampere rating of the utility equipment such as transformers, distribution lines and generators, that places a restriction on the total equipment load that can be connected to a typical home or office wall plug with specified maximum r.m.s. current rating.

A. Power Quality Survey

Power Quality (PQ) Survey Reports have pointed out incompatibility between the tolerances of electronics appliances to power disturbances [1-5]. The severely affected industries are Medical Centers, Chemical and Pharmaceuticals, Automobile Manufacturing Plants, Paper Mill, Textile fibres, Semiconductor Industry, Glass works, Rubber production, Broadcasting facility etc [1-4], where utility voltage sag events cost millions of dollars loss per year.

Some important observations of PQ surveys are the following:

- More low r.m.s. voltage sag events occur at the PCC than at the substation or on the utility distribution feeders.
- Some weather events also cause low r.m.s. voltage events such as thunder storms.
- Majorities of voltage dip events are 10-20% voltage sags. More disturbances occur above 70% of nominal line voltage level than in the area below that level. The occurrences of most severe sag events are least frequent.
- The survey suggests that there are definite areas where product design tolerance is a must if any type of reasonable performance is to be expected [2, 4].

Today, every custom power technology which can provide high control band-width and very fast and good controllability involves power electronic converters. Though the cost of fast acting semiconductor switching devices are getting lowered with the advancement of semiconductor physics technology, still their cost is the prime factor that make this PQ compensating equipment very costly. Efforts are made to minimize the cost of these equipment, by minimizing equipment rating and maximizing their functional capability or making them multi-purpose [6].

The present paper highlights the performance of a multi-purpose PQ compensating equipment Unified Power Quality Conditioner (UPQC) for non-linear and voltage sensitive loads. The developed Unified Power Quality Conditioner (UPQC) has following facilities.

- ♦ It eliminates the harmonics in the supply current, thus improves utility current quality for nonlinear loads.

◆ UPQC provides the VAR requirement of the load, so that the supply voltage and current are always in phase, therefore, no additional power factor correction equipment is necessary.

◆ UPQC maintains load end voltage at the rated value even in the presence of supply voltage sag.

◆ The voltage injected by UPQC to maintain the load end voltage at the desired value is taken from the same dc link, thus no additional dc link voltage support is required for the series compensator.

The injected voltage maintains quadrature advance relationship with the supply current, so no real power is consumed by the series compensator in steady state; hence the equipment is termed as UPQC-Q to highlight this aspect.

The series compensator also shares the VAR load along with the shunt compensator, so the VA rating of shunt compensator reduces.

The control scheme developed is applicable to single phase as well as three phase schemes. A new PC-based hybrid controller has been proposed, combining analog and digital controllers, having good accuracy, speed, flexibility and ease of implementation.

The dynamic sag controller can take care of the phase quadrature relationship in case of variable voltage sag and variable load condition.

Computer simulation has been made using SABER simulator. A laboratory proto-type is built and the simulation results are validated by experimental results.

II. CONFIGURATION

The UPQC-Q consists of two three phase inverters connected in cascade in such a manner that inverter – II (synchronous link converter VAR compensator (SLCVC)) is connected in parallel with the load. Inverter – I (series compensator) is connected in series with the supply voltage through a transformer (Fig. 1). The main purpose of the SLCVC is to compensate for the reactive power demanded by the load, to eliminate the harmonics and to regulate the common dc link voltage. The SLCVC operates with hysteresis current controlled mode to make the supply current in phase with the supply voltage.

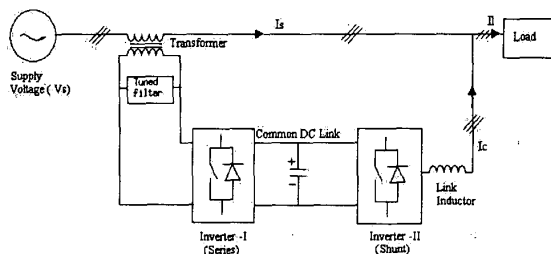

Fig.1 Schematic diagram of UPQC-Q

The series compensator is operated in PWM voltage controlled mode. It injects voltage in quadrature advance to

the supply voltage (current) such that the load end voltage is always maintained at the desired value. Therefore, at steady state, the series compensator does not consume any active power. Additionally it shares the VAR of the load with SLCVC, so that the loading on SLCVC is less. The two inverters operate in a coordinated manner.

III. PHASOR DIAGRAM

The phasor diagram of Fig. 2 explains the operation of UPQC-Q for the fundamental power frequency. When the supply voltage V_{s1} (rated), therefore the load voltage V_1 ($|V_1|=|V_{11}|=|V_{s1}|$) is also at the rated value, and the load current is I_{11} ($|I_{11}|=|I_1|$) with a power factor angle ϕ , the SLCVC compensates the reactive component I_{c1} of load, resulting in unity power factor. Hence the load always draws only in-phase component I_{s1} from the supply.

Now if there is a sag in the supply such that the supply voltage falls to V_{s2} ($|V_{s2}|<|V_{s1}|$), the series compensator injects V_{inj} such that the magnitude of the resultant voltage at the load end (V_{12}) is maintained at $|V_1|$. Thus, V_1 makes an angle θ with V_{s2} . The load current changes to I_{12} . The shunt inverter injects I_{c2} in such a fashion that the utility current is given by

$$I_{s2}=I_{12} (\cos\phi/\cos\theta) \quad (1)$$

thus the power balance of the whole system is maintained.

The quadrature voltage injection of series compensator is selected in advance to that of the supply current because that minimises the VAR loading on SLCVC, since a part of load VAR is shared by the series compensator also, as described in section V.

Between the control loops, the analog hysteresis current control loop used for the shunt compensator (Inv-II) is much faster. For nonlinear loads, harmonic elimination and VAR compensation are first achieved by the shunt compensator,

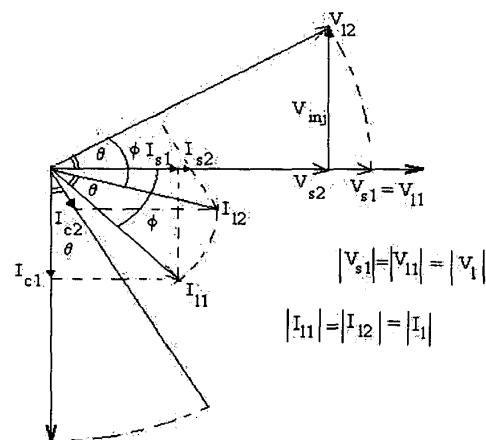

Fig.2 Phasor diagram

so the utility sees the load to be always linear and at unity power factor. A slower digital controller simultaneously corrects the voltage sag through the series compensator. Due to faster compensation by shunt controller the series controller always sees the supply current to be in phase with the voltage. The two loop speeds are chosen such that in no case these two controllers can interfere with each other and cause instability.

IV. CONTROL STRATEGY

Fig. 3 shows per phase control block diagram of the controller used for UPQC-Q. V_{dc} (reference) is selected depending upon the maximum VAR to be compensated and the percentage sag ($x\%$) to be mitigated. The error in the dc link voltage ($V_{dc}^* - V_{dc}$) gives a direct measure of active power requirement of both load and UPQC-Q from the supply.

To enhance the speed of response and also to retain the flexibility to modify parameters of the controller, a new hybrid type of controller has been developed. Here the dc link voltage control is completely PC based software control.

After the dc link voltage (V_{dc}) is sensed and compared internally with the reference dc link voltage (V_{dc}^*), the error is processed through a software PI controller. The output of the PI controller is multiplied by the sinusoidal template to produce the reference current for the supply (i_s^*). To keep the supply current (i_s) within a hysteresis band, an analog hysteresis comparator is implemented for fast and accurate control of current. The hysteresis window width determines the quality of supply current spectra and the switching frequency of the SLCVC. Thus the hybrid control method maintains the accuracy, speed and flexibility, combining the advantages of analog and digital controllers.

For the series compensator, the supply voltage peak (V_{s_peak}) is sensed. An appropriate sinusoidal template, which takes care of the phase shift due to the tuned filter at the output of the series compensator (75° shift advance in Fig. 3), for quadrature injection is also sensed through AD channels, and a feed-forward loop is used to calculate the modulating signal (m_1).

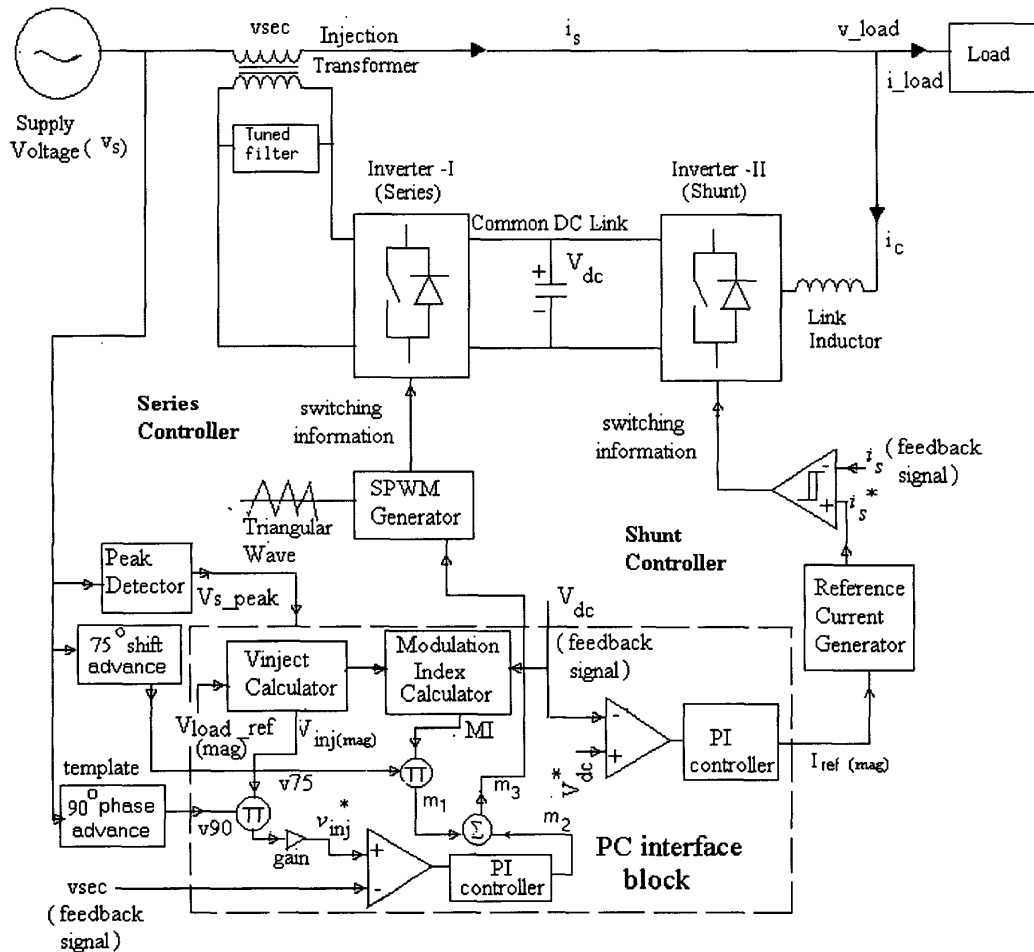

Fig. 3 Per phase control block diagram

The actual voltage injected (v_{inj}) is also sensed through ADC and compared internally with the reference injected voltage (v_{inj}^*). v_{inj}^* is generated by multiplying a 90° phase advance sinusoidal template with the calculated magnitude of the injected voltage ($V_{inj(mag)}$).

The error is processed through a PI controller, which acts as a feedback loop (m_2). This adding with m_1 modifies the final modulating signal m_3 . m_2 takes care of any incremental change in phase angle that may occur due to load current variation. m_3 is compared with a triangular wave (5 kHz) to generate the switching signals for series compensator.

When a sag is detected such that $|V_{s2}| < |V_{s1}|$ (rated), $V_{inj} = \sqrt{V_{s1}^2 - V_{s2}^2}$ (2)

From PWM method,

$\sqrt{2} V_{inj} = m (V_{dc}/2)$, where m is the modulation index. Therefore,

$$m = (2 \sqrt{2} V_{inj}) / V_{dc} \quad (3)$$

and if x is the p.u. sag to be mitigated, minimum dc link voltage is given by

$$V_{dc} = 2 \sqrt{2} \sqrt{x(2-x)} V_{s1} \quad (4)$$

for maximum MI=1 (taking the transformer turns ratio 1:1).

V. VA REQUIREMENT OF UPQC-Q

From Fig. 2 phasor diagram, it can be found that for each phase of fundamental power frequency

$$V_{I1} = V_{I2} = V_{s1} = \text{Constant} = 1 \text{ p.u.} \quad (5)$$

If load current is assumed to be $I_1 = I_{I1} = I_{I2} = 1$ p.u., with fundamental p.f. = $\cos \phi$,

$$\text{active power demand in the load remains the same,} \quad (6)$$

$$\text{i.e. } V_{s1} I_s = V_{I1} \cos \phi = \text{Constant} \quad (7)$$

In case of sag when $V_{s2} < V_{s1}$,

if x denotes the p.u. sag,

$$V_{s2} = (1-x) V_{s1} = (1-x) \text{ p.u.} \quad (8)$$

Now, to maintain constant active power

$$V_{s1} I_{s1} = V_{s2} I_{s2} \quad (9)$$

$$\text{Or, } I_{s2} = (1 \cdot I_1 \cos \phi) / (1-x) = \cos \phi / (1-x) \text{ p.u.} \quad (10)$$

As the injected voltage is injected in quadrature with the supply, the resultant load voltage V_{I2} makes an angle θ (Fig. 3) with the supply V_{s2} .

$$V_{inj} = \sqrt{V_{s1}^2 - V_{s2}^2} \\ \therefore \frac{V_{inj}}{V_{s2}} = \tan \theta, V_{inj} = V_{s2} \tan \theta, V_{inj} = (1-x) \tan \theta \quad (11)$$

$$\therefore \text{Series VA Rating} = V_{inj} \cdot I_{s2} = \cos \phi \tan \theta \text{ p.u.} \quad (12)$$

The shunt inverter current can be calculated from the trigonometry of the vector diagram (fig.3)

$$I_{shunt} = \sqrt{I_{I2}^2 + I_{s2}^2 - 2 I_{I2} I_{s2} \cos(\phi - \theta)} \\ = \frac{\sqrt{(1-x)^2 + \cos^2 \phi - 2 \cos \phi \cos(\phi - \theta)(1-x)}}{(1-x)} \text{ p.u.} \quad (13)$$

\therefore Shunt VA Rating

$$V_{I2} I_{c2} = \frac{\sqrt{(1-x)^2 + \cos^2 \theta - 2 \cos \phi \cos(\phi - \theta)(1-x)}}{(1-x)} + \frac{(1-x)^2 + \cos^2 \theta - 2 \cos \phi \cos(\phi - \theta)(1-x)}{(1-x)^2} Z_{SLC} \text{ p.u.} \quad (14)$$

where Z_{SLC} is the shunt inductance impedance.

Adding (12) and (14) the total VA rating of the UPQC-Q can be evaluated.

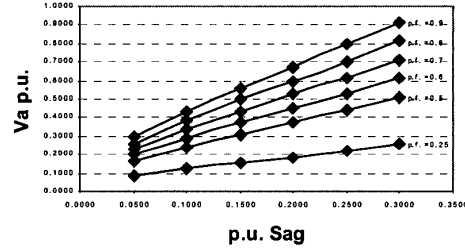

Fig. 4 Series VA Loading curve of UPQC-Q

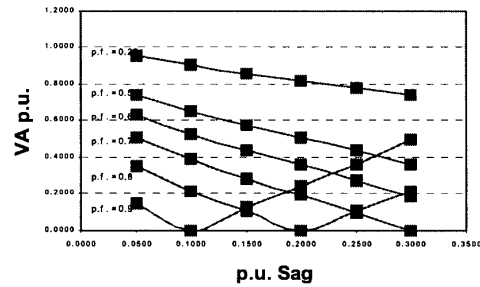

Fig. 5 Shunt VA loading curve of UPQC-Q

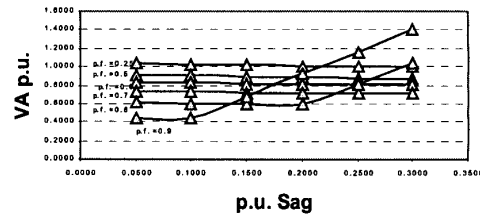

Fig. 6 Combined VA loading curve of UPQC-Q

It is interesting to observe from Fig. 2 that if supply voltage sag be such that for a load power factor angle ϕ , the angle θ becomes equal to ϕ , then from (1), it can be inferred $I_{s2} = I_{I2}$ (15), then I_{shunt} as given in (13) becomes zero. Fig. 4 shows the series VA loading of UPQC-Q under different voltage sag and load power factor condition. For several power factors and voltage sag, the condition of zero VA loading of the

shunt compensator can be observed in Fig. 5.

If $\theta < \phi$, then the two compensators shares the load VAR. But if the supply voltage sag is such that $\theta > \phi$, then SLCVC current has to increase again to bring back leading power factor to unity. The latter condition may occur with small voltage sag (say 15%) when load power factor is already high (e.g. 0.9), as seen in the combined loading curve in Fig.6.

VI. EXPERIMENTAL RESULTS

The detailed simulation and experimental investigation of single phase as well as three phase UPQC-Q has been carried out. Some typical experimental results for nonlinear diode bridge rectifier load are reported here.

Single phase UPQC-Q[9] performance is observed from Figs. 7-10. Fig. 7 shows supply current and the load current for a nonlinear load. It can be seen that with the UPQC-Q, the supply current is sinusoidal when the load current contains harmonics (THD 14% as seen in Fig. 8). The actual current follows the reference current within an appropriate hysteresis band. The measured THD is 3.75% (Fig. 9), which is well within permissible limit of 5% of IEEE-519.

Fig. 10 shows the load and supply voltage waveforms. The Trace-3 shows the actual injected voltage in a scaled down form with a multiplication factor of 38. The measured THD of the load voltage after series compensation for 14.8% sag is 3.5%. As seen in the figure, the injected voltage is in quadrature advance with respect to the supply voltage.

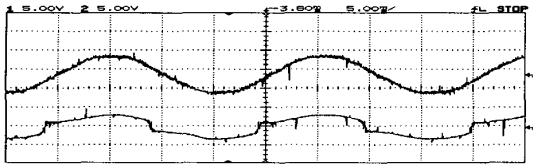

Fig. 7 Trace-1: Supply current, y axis: 5A/div
Trace-2: Load current x axis: 10ms/div

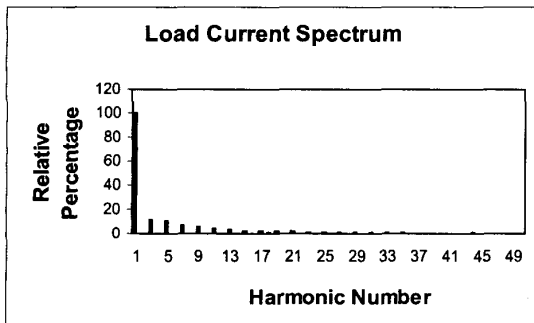

Fig. 8 Harmonic spectrum of diode bridge rectifier load current

Three phase UPQC-Q performance is observed from Figs. 11-14. Fig. 11 shows that for supply voltage sag of 8%, the (Ch-1) load voltage remains to its specified level. Ch-2

shows the peak of supply voltage. Here 1V in the sensor output is equivalent to 10.53V in actual circuit. Fig. 12 shows the actual injected voltage of a series inverter during voltage sag.

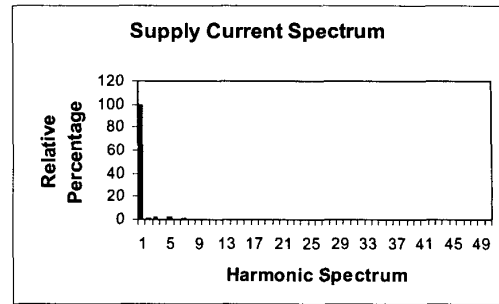

Fig. 9 Harmonic spectra of Utility current

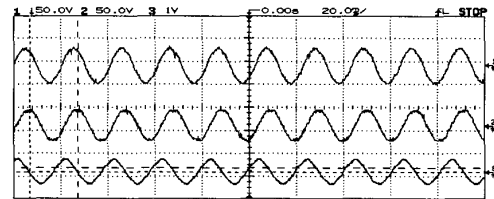

Fig. 10 Trace-1: Load voltage, y axis : 50v/div
Trace-2: Supply voltage, y axis : 50v/div
Trace-3: Series injected voltage/38.
y axis : 1v/div x axis : 20ms/div

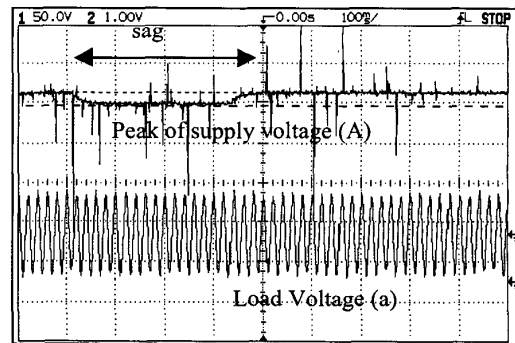

Fig.11. Supply and Load Voltage Profile (A Phase)
Trace 1: Load Voltage
Trace 2: Peak of Supply Voltage

Fig. 13 shows three phase nonlinear load currents and sinusoidal utility currents after power quality correction by UPQC-Q. Fig. 16 shows that supply current and voltage are

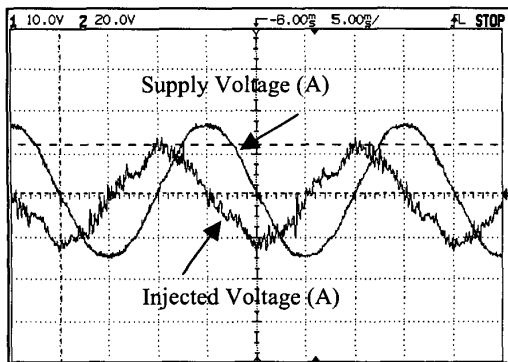

Fig. 12 Injected Voltage and Supply voltage in quadrature
Trace 1: Injected Voltage Trace 2: Supply Voltage

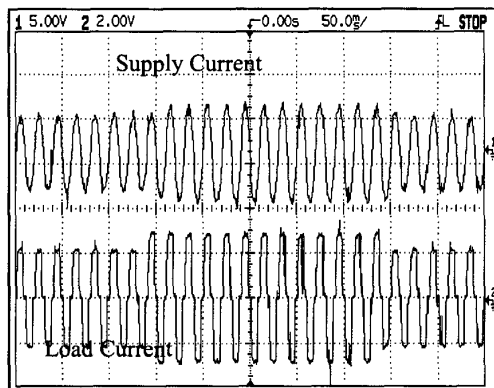

Fig. 13 Supply current and Non-linear Load Current (Phase A)
Trace 1: Supply Current Trace 2: Load Current

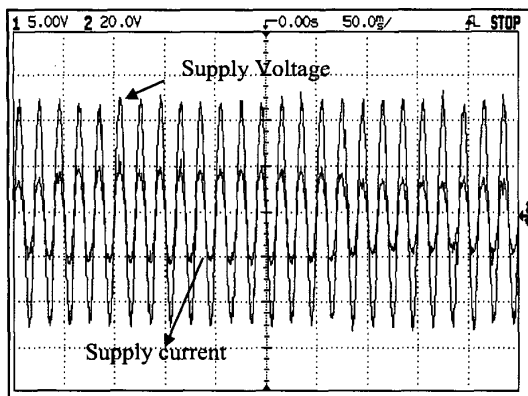

Fig. 14 Supply Voltage and current (Phase A)
Trace 1: Supply Current Trace 2: Supply Voltage

in phase even in the transient load change (25% increase and decrease) condition. The experimental results fulfil the control objectives satisfactorily.

VII. CONCLUSION

The operation and rating issues of a Unified Power Quality Conditioner (UPQC-Q) are highlighted in this paper. It is seen that the UPQC-Q is capable of maintaining harmonic isolation between utility and load. The utility voltage sag does not affect the load voltage as the series inverter injects adequate amount to maintain the load voltage to its desired value. On the other hand, the load VAR and harmonics does not pollute the utility as their demand is supported locally by the shunt inverter of the utility.

Laboratory experiments confirm good performance of UPQC-Q in case of supply voltage sag and harmonic elimination of non-linear load to the utility.

VIII. ACKNOWLEDGMENT

The authors gratefully acknowledge the financial support from Department of Science and Technology (DST), Govt. of India, to carry out the research.

IX. REFERENCES

- [1] T. Key and J. S. Lai, "Comparison of Standards Limiting Harmonic Distortion in Power Systems," *IEEE Trans. on Ind. Appl.*, Jul./August 1993, pp. 683-695.
- [2] D. O. Koval, R. A. Bocancea, M. B. Hughes, "Canadian National Power Quality Survey: Frequency and Duration of Voltage Sags and Surges at Industrial Sites," *IEEE Trans. on Industry Applications*, vol. 34, no. 5, Sept./Oct. 1998.
- [3] M. Negnevitsky et al, "Survey of Power Quality Problems in Tasmania," *Proceedings of the 4th Int. Conference on Advances in Power System Control, Operation and Management, APSCOM-97*, HongKong, Nov. 1997.
- [4] R. Lamedica, G. Esposito, et al, "A Survey on Power Quality Cost in Industrial Loads," *IEEE Winter Power Meeting, 2001*, vol. 2, pp. 938-943.
- [5] D. S. Dorr et al, "Interpreting Recent Power Quality Surveys to Define the Electrical Environment," *IEEE Trans. on Industry Applications*, vol. 33, no. 6, Nov./Dec 1997.
- [6] H. Akagi, "New trends in Active Filters for Power Conditioning," *IEEE Trans. Ind. Application*, vol. 32, no. 6, Nov/Dec. 1996.